

MAVERICK SPOT LIGHT

TECHNICAL SHEET
KL-SP00021



KEYLIGHT

SPAIN

PRODUCTOS DE ILUMINACION

DRAWING

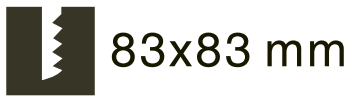
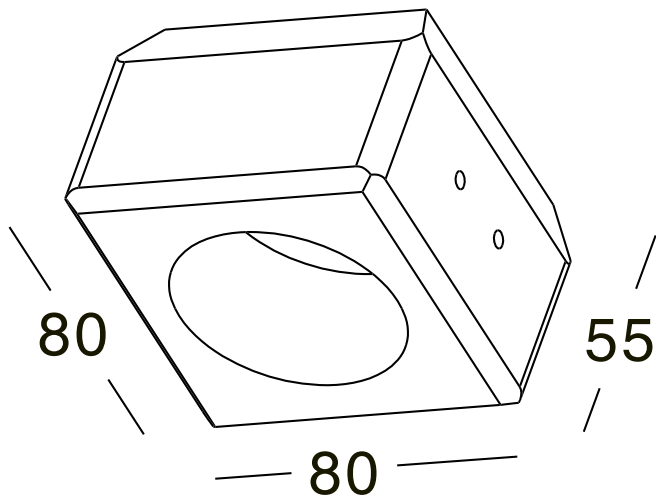

SPECIFICATIONS

Product Code	KL-SP00022
Power	GU10/MR16
Input	220-240V
Material	Gypsum
Dimensions	80mm*80mm*55mm
Cut-out	83mm*83mm

